





4000mm (W) Portable LightBox

Parts





-  Vertical Profile x 4
-  Horizontal Profile x 8
-  Support Pole x 10
-  90 Deg Corner x 2
-  Full Foot Profile x 2
-  Cross Connector x 3
-  Straight Connector x 8
-  Power Supply x 4
*x1 power Bank Per 3 light Strips

ASSEMBLY INSTRUCTIONS

Remove all products from packaging.

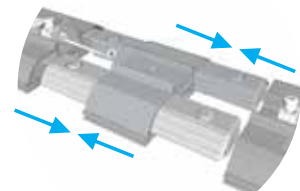
- 1** Join the horizontal profile (LED Light strip) extrusion by aligning it with the straight connector, then push them together until securely slotted into each other.



- 2** 

After assembling the base, join the feet by pushing them together until they click. Add the vertical profile extrusions by connecting it to the feet.

- 2a** Both the Left and Right Handside Vertical strips require the sides which include the cables going up to the top lightstrips

ASSEMBLY INSTRUCTIONS

3

Align the vertical profile extrusions with the straight connector and push them together until securely slotted into one another.

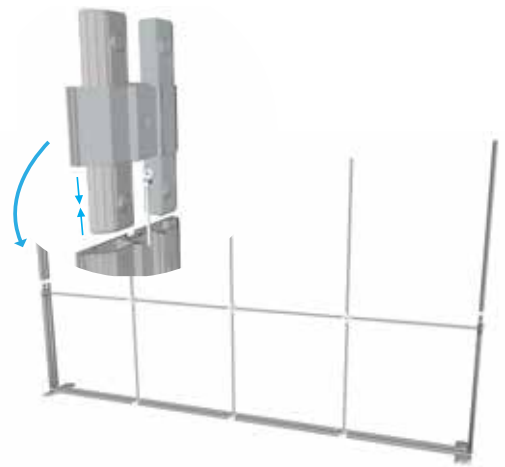

4

To enhance stability, incorporate horizontal and vertical support poles. Slot them together by rotating into the grooves of the straight extrusion, including when inserting into the centre cross connector.

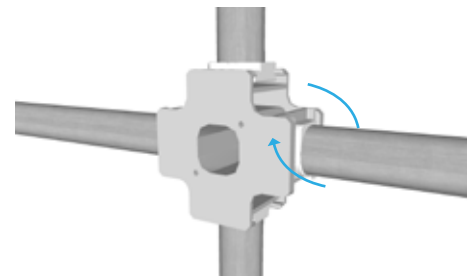
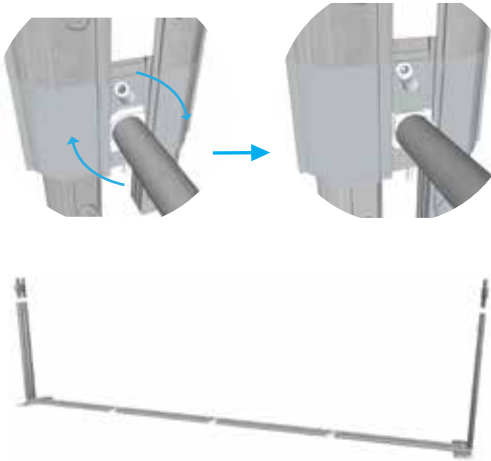

5

Attach the top vertical profile components to the straight connector, then add the top vertical support pole and connect it to the cross connector.

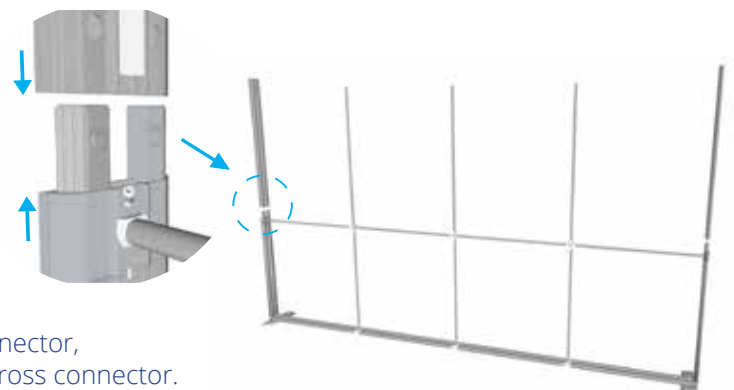

ASSEMBLY INSTRUCTIONS

6

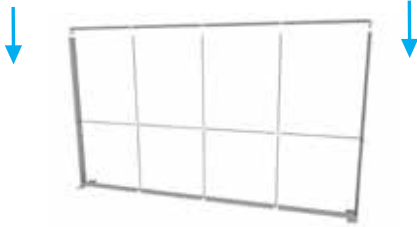

Repeat the process from step 1 to connect the horizontal profile (LED Light strip) extrusion. Align it with the straight connector and push together until securely slotted into one another. Repeat with the 90-degree corner component to complete your Portable Lightbox.



Once the lightbox construction is finished, connect the provided power supply(s) through the frame extrusion and into the internal wires as shown in the illustration.

7

One power supply connects to the LED light strip on the bottom row, while the other connects to the cable within the vertical extrusion to power the top LED light strips.

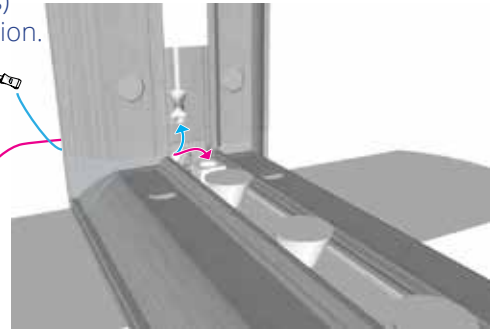
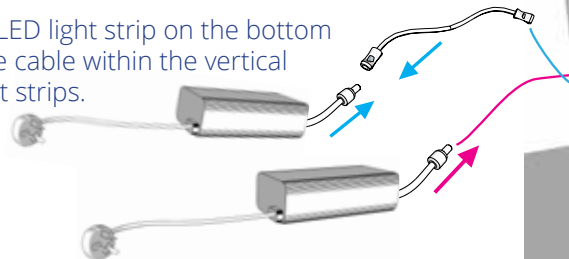
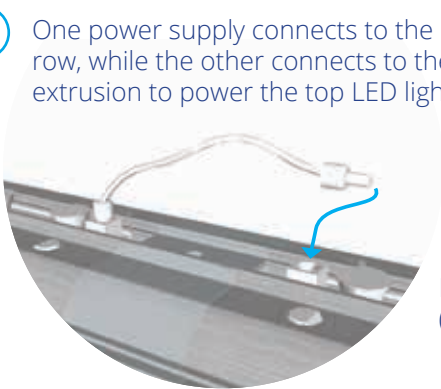

Each LED light strip is linked together using a male-to-male electrical cable (up to three LED light strips can be connected from one power supply)

8

Once all wires are connected and plugged in, insert your chosen fabric graphic to finish your lightbox display.

